

20 Years BBG

3 Continents

A dark blue hexagon containing a white outline of a globe showing the continents.

**100%
Performance**

A dark grey hexagon containing white outlines of a wrench and a screwdriver crossed at their handles.

1 Partner

A white hexagon containing a dark blue outline of two hands shaking in a firm grip.

BBG
Competence to the details

| | |
|---------------------------------|--|
| Headquarter: | Mindelheim Germany, founded 1960 |
| Bought: | 1999 by Hans Brandner |
| Subsidiaries (100%): | BBG Asia Ltd, Changchun China, founded in 03/2006 BBG Shanghai, Shanghai China, founded in 10/2013 BBG North America, Oxford USA, founded in 05/2014 |
| Employees: | 110 at BBG Mindelheim - 65 at BBG Asia - 9 at BBG North America |
| Turnover: | BBG Group → 27 Mio. Euro (2018) |
| Business areas: | Tool & Machinery development and manufacturing, Production plants |
| Global capacity: | 130 tools/year |
| Capacity Mold Carriers | Capacity of 70 carriers/year (100% at BBG-Germany) |
| BBG GlassLine: | 20 PUR-metering machines installed (launched in 2015) |
| Carrier and Tool Design: | Made in Germany |

PUR glass encapsulation tools



For backlites, backlites in convertible softtops, quarter lites, roofs, side glasses and windshields

Tools to produce parts of composite materials

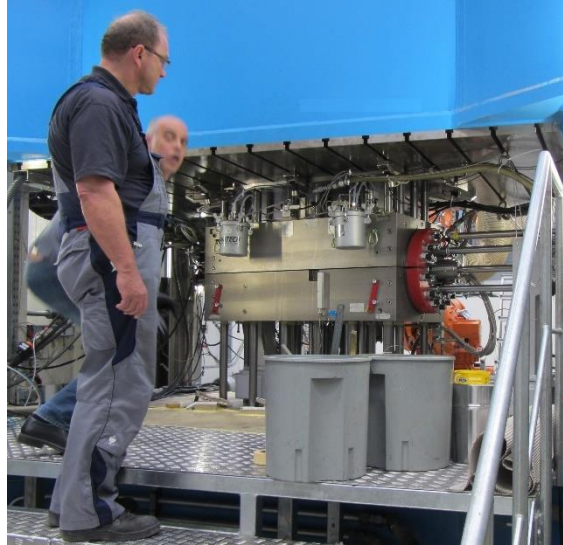

For example: HD-RTM tool to manufacture high-pressure vessels made of CFRP

Tools to produce parts insulation PUR



For example: Insulation of hot water storage tanks

Mold Carrier optimized for glass encapsulation



For example:
BFT-P V8 with more than 100 options for individual configuration

Presses optimized to manufacture composite



For example:
BFT-C to produce window frames of CFRP for Airbus A350

Custom machine engineering



For example:
BFT-B to produce bath tubs or shower trays

Easy Control 2.0

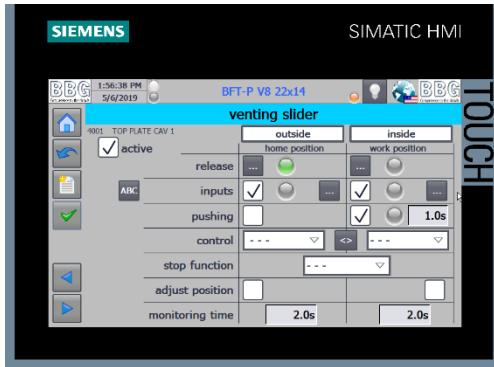

Remote Maintenance Box



Innovation for RIM tools

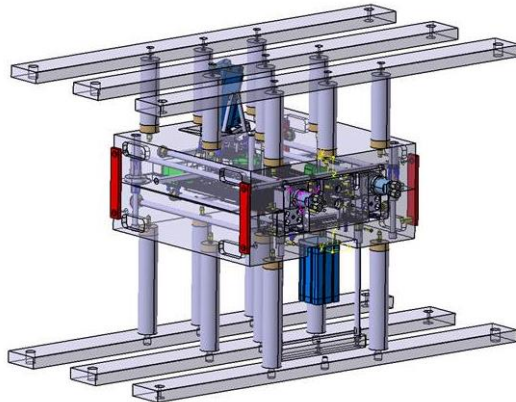

Carrier ergonomics

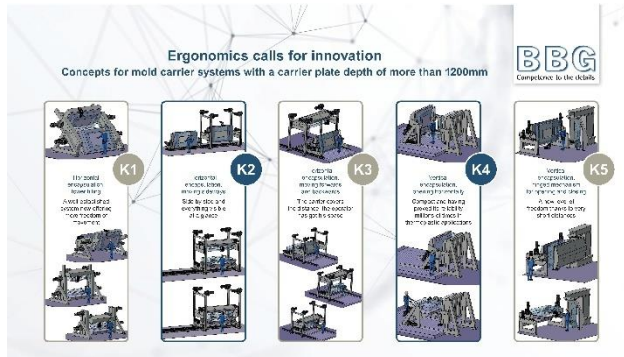

BBG Tooling Department Team



New Rough milling machine BF3500



New 6-axis milling machine RT3000



New 5-axis high speed milling machine DMU400

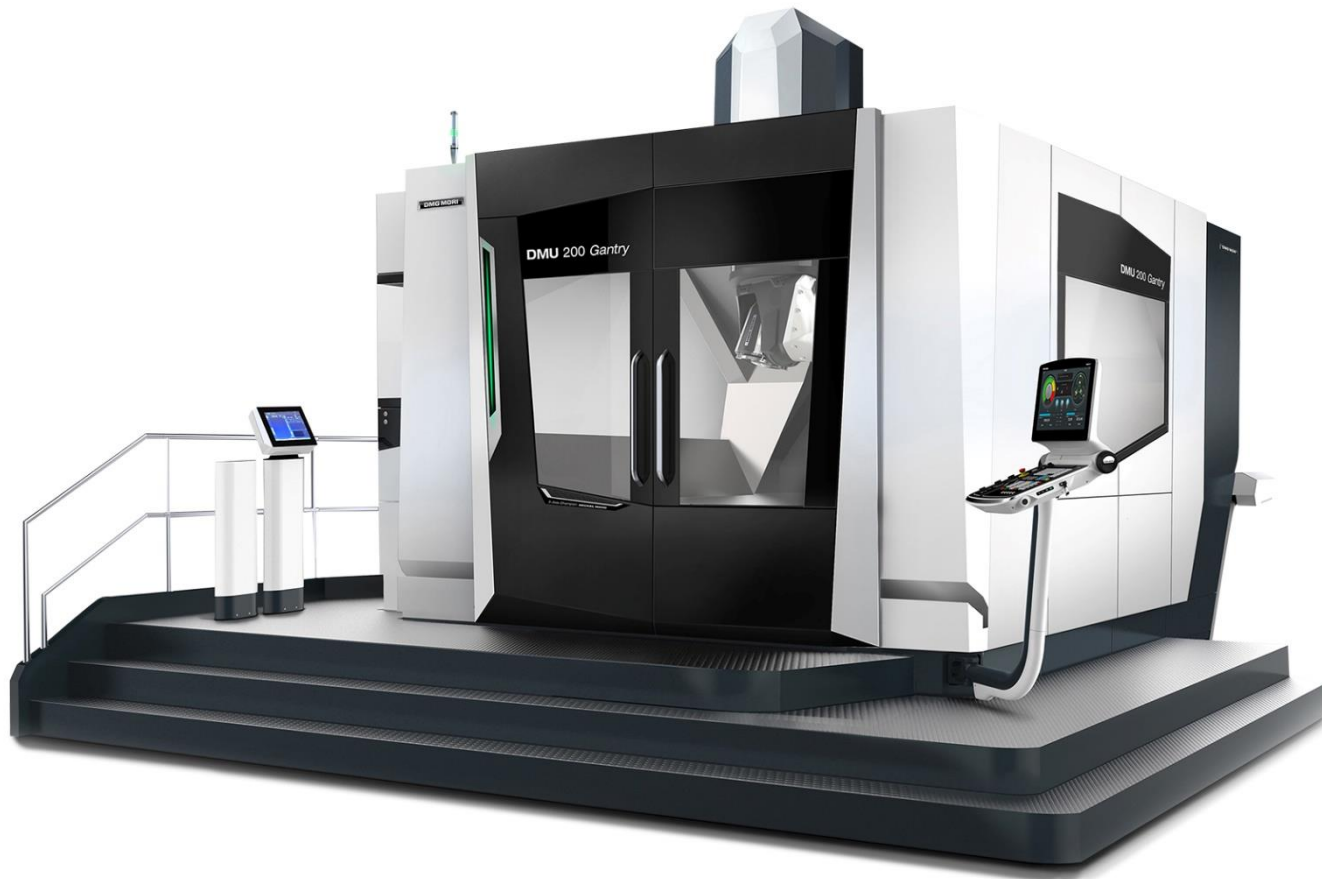



Ergonomics calls for innovation

„We can help you grasp the dimensions“



294529_00378847

z.1
z.2
z.3
z.4

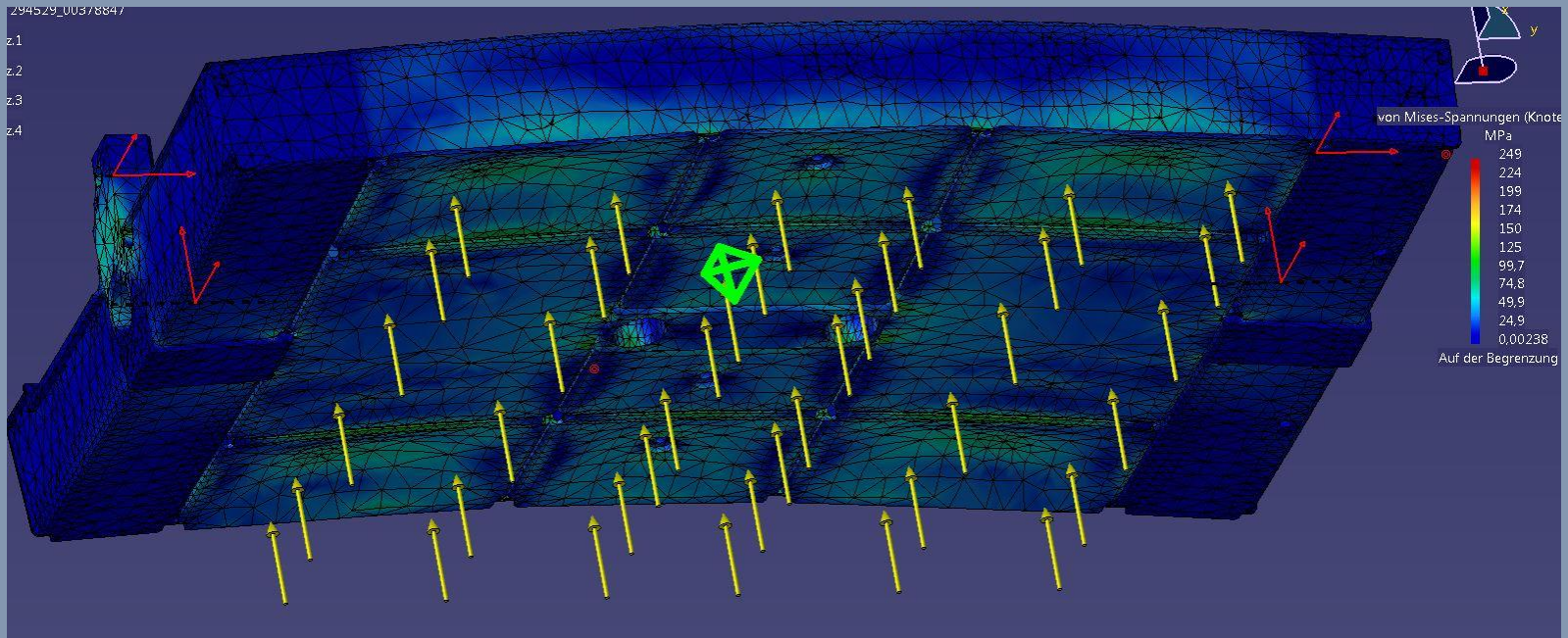

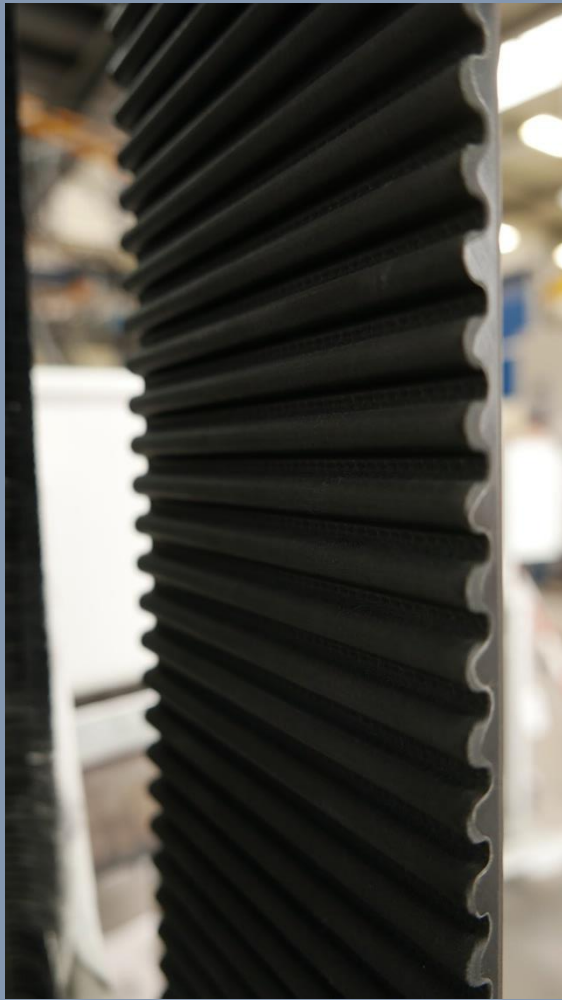

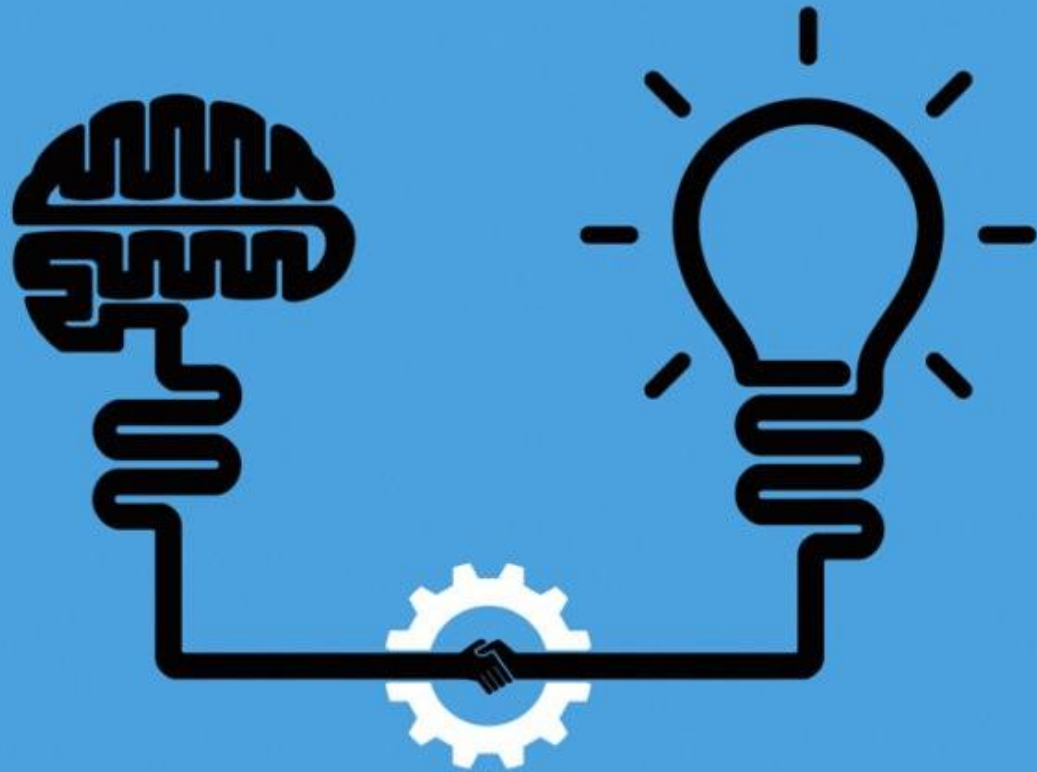



Vielen Dank für Ihre Aufmerksamkeit
Thank you very much
for your attention
谢谢大家的到来